

ST. S.P.A.

SB 50TX (2018)

294506028/UVT

Spare parts list Reservdelar Repuestos Ersatzteile Pièces détachées Reserve onderdelen Catalogo ricambi

- Use ST. S.p.A. Genuine Spare Parts specified in the parts list for repair and/or replacement.
- The contents described in the parts list may change due to improvement.
- The drawings of the spare parts are only indicative And might Not represent the part in question exactly.
- The indications "right" - "left" - "front" - "rear" refer to the position of the operator when using the machine.
- When placing orders of parts for repair And/Or replacement, make sure that the illustrated parts list Is the one applying to the machine's year of manufacture, as shown on the identification plate attached to the machine.

All rights reserved. No part Of this material may be reproduced Or transmitted, in any form Or by any means, electronic Or mechanical, including photocopying, recording Or by any information storage And retrieval system, without permission in writing from ST. S.p.A.

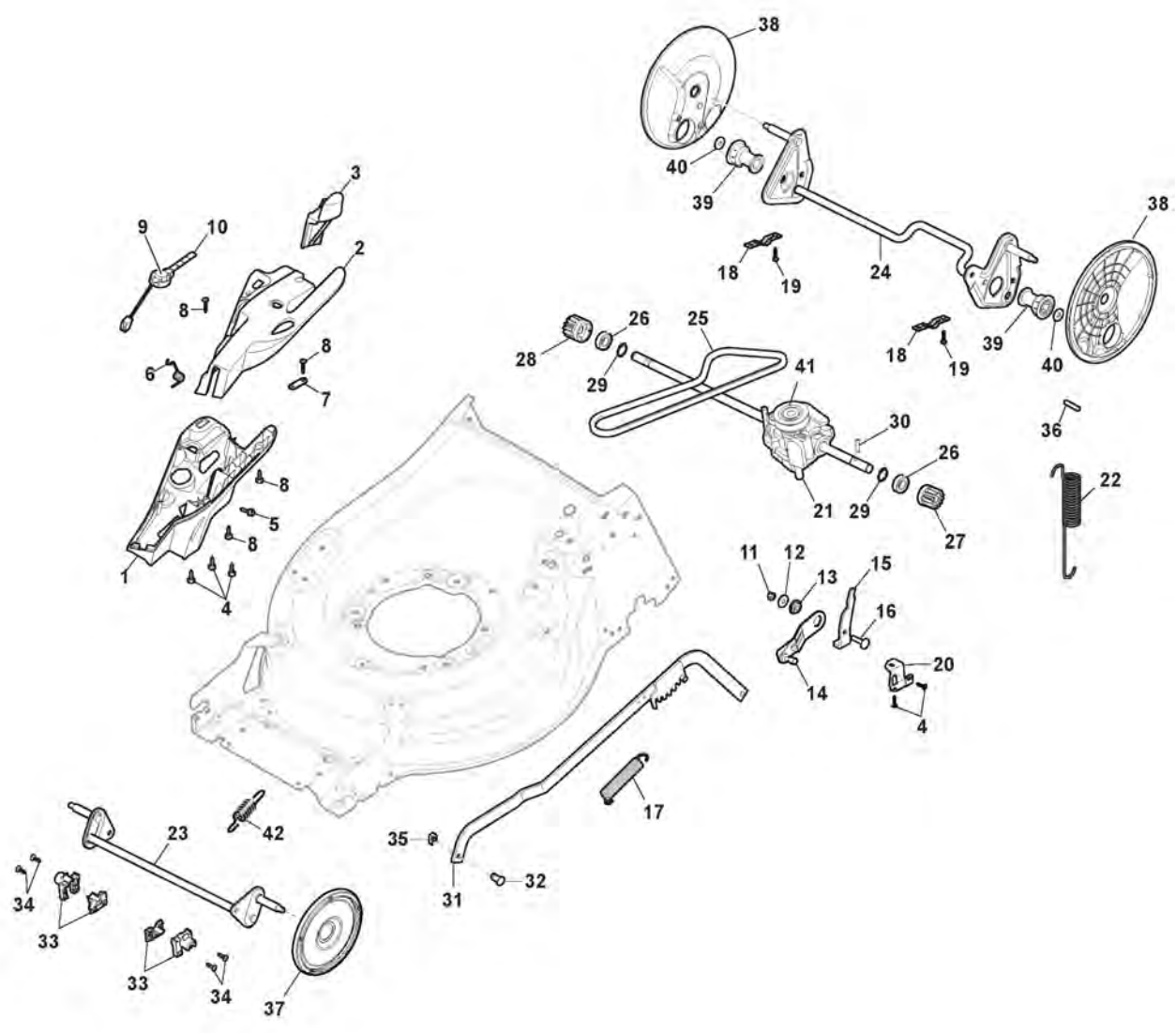

Châssis Et Reglage Hauter Decoupe

Réf. N°	Q.té :	Code article	Description	Articles	De	Jusqu'à
1	1	322055262/0	Couvercle Inferieur			
2	1	322055263/0	Couvercle supérieur			
3	1	322602026/0	Bouton			
4	5	112728699/0	Vis			
5	1	125943004/0	Vis			
6	1	122450477/0	Ressort			
7	1	322981471/1	Plaquette			
8	5	112728697/0	Vis			
9	1	322602027/0	Lentille			
10	1	322602028/0	Télespectateur			
11	1	112154510/0	Ecrou			
12	1	112523040/0	Rondelle			
13	1	122517873/0	Pivot			
14	1	381003475/0	Levier, Reglage Hauteur	To 31-August-2015		
14	1	381003475/1	Levier, Reglage Hauteur	From 01-September-2015 To 31-August-2017		
14	1	381003475/2	Levier, Reglage Hauteur	From 01-September-2017		
15	1	322778475/0	Etrier			
16	1	112815270/0	Vis			
17	1	122450480/0	Ressort			
18	2	322545152/0	Plaquette			
19	4	112728697/0	Vis			
20	1	322778473/0	Etrier	To 31-August-2018		
20	1	322778473/1	Etrier	From 01-September-2018		
21	1	181003114/0	Groupe Traction			
22	1	122450478/0	Ressort			
23	1	381302881/0	Axe Roues Avant			
24	1	381302891/0	Axe Roues Arriere			
25	1	135063900/0	Courroie			
26	2	119216035/0	Roulement			
27	1	122570110/1	Pignon Droit			
28	1	122570120/1	Pignon Gauche			
29	4	112608600/0	Seeger			
30	2	122753000/0	Goupille			
31	1	381002047/0	Tige Commande de Roues			
32	2	122519820/0	Pivot			
33	2	322785305/0	Support	To 31-August-2015		
33	2	322785305/1	Support	From 01-September-2015		
34	4	112728697/0	Vis			
35	2	112436051/0	Plaquette			
36	1	112645708/0	Pivot			
37	2	322600247/0	Protection Roue			
38	2	322600205/1	Protection Roue			
39	2	322042068/0	Douille			
40	2	112521371/0	Rondelle			
41	1	122601909/0	Poulie			
42	1	122450481/0	Spring Front Axle			

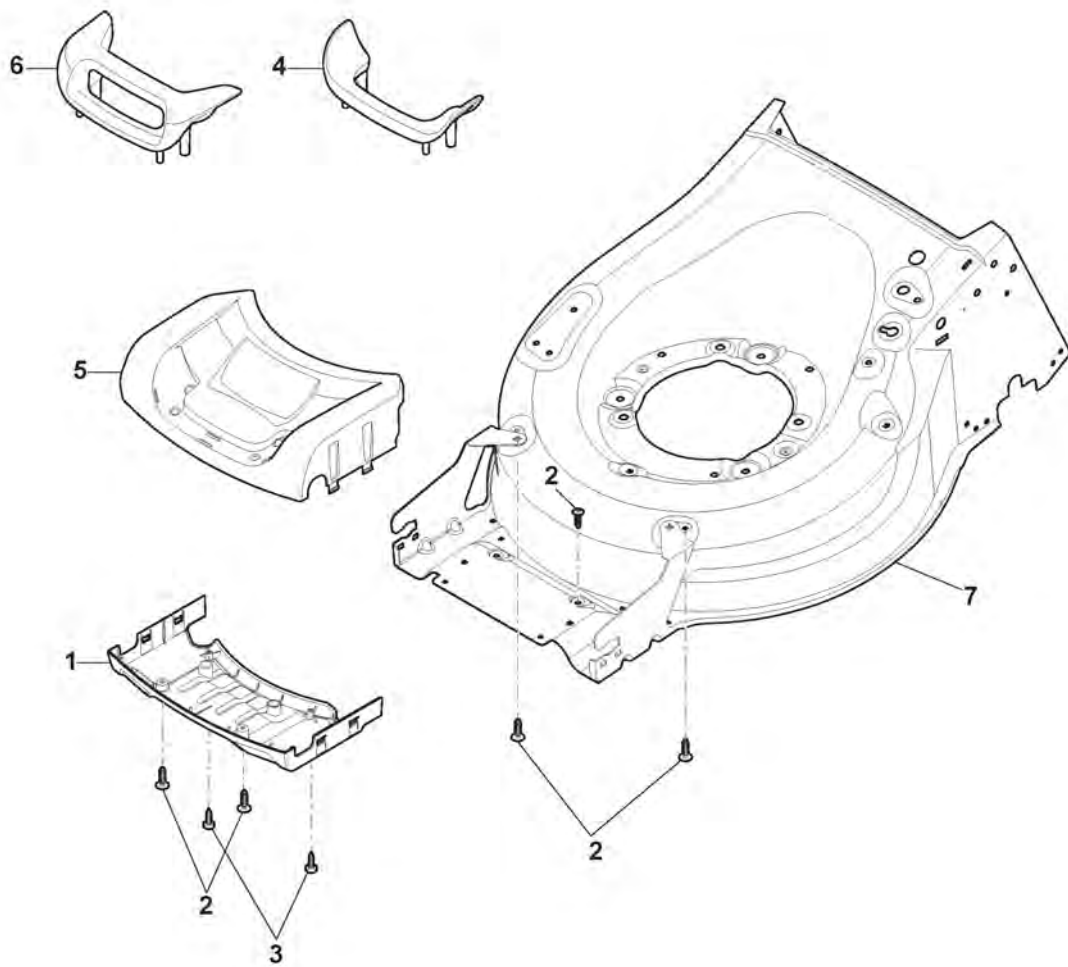

Mesque

Réf. N°	Q.té :	Code article	Description	Articles	De	Jusqu'à
1	1	322500111/0	Admission d'air			
2	6	112728697/0	Vis			
3	2	112728699/0	Vis			
4	1	322055524/0	Renfort	To 31-december-2018		
4	1	322055524/1	Renfort	From 01-January-2019		
5	1	322226215/0	Mesque, Rouge	Light Red		
5	1	322226229/0	Mesque, Noir	Black		
5	1	322226243/0	Mesque, Rouge	Dark Red		
6	1	322393742/0	Poignée	To 31-december-2018		
6	1	322393742/1	Poignée	From 01-January-2019		
7	1	381004776/0	Châssis Rouge	To 31-August-2016		
7	1	381004792/0	Châssis Rouge	From 01-September-2016 To 31-August-2018		
7	1	381004853/0	Châssis Gris	From 01-September-2018		

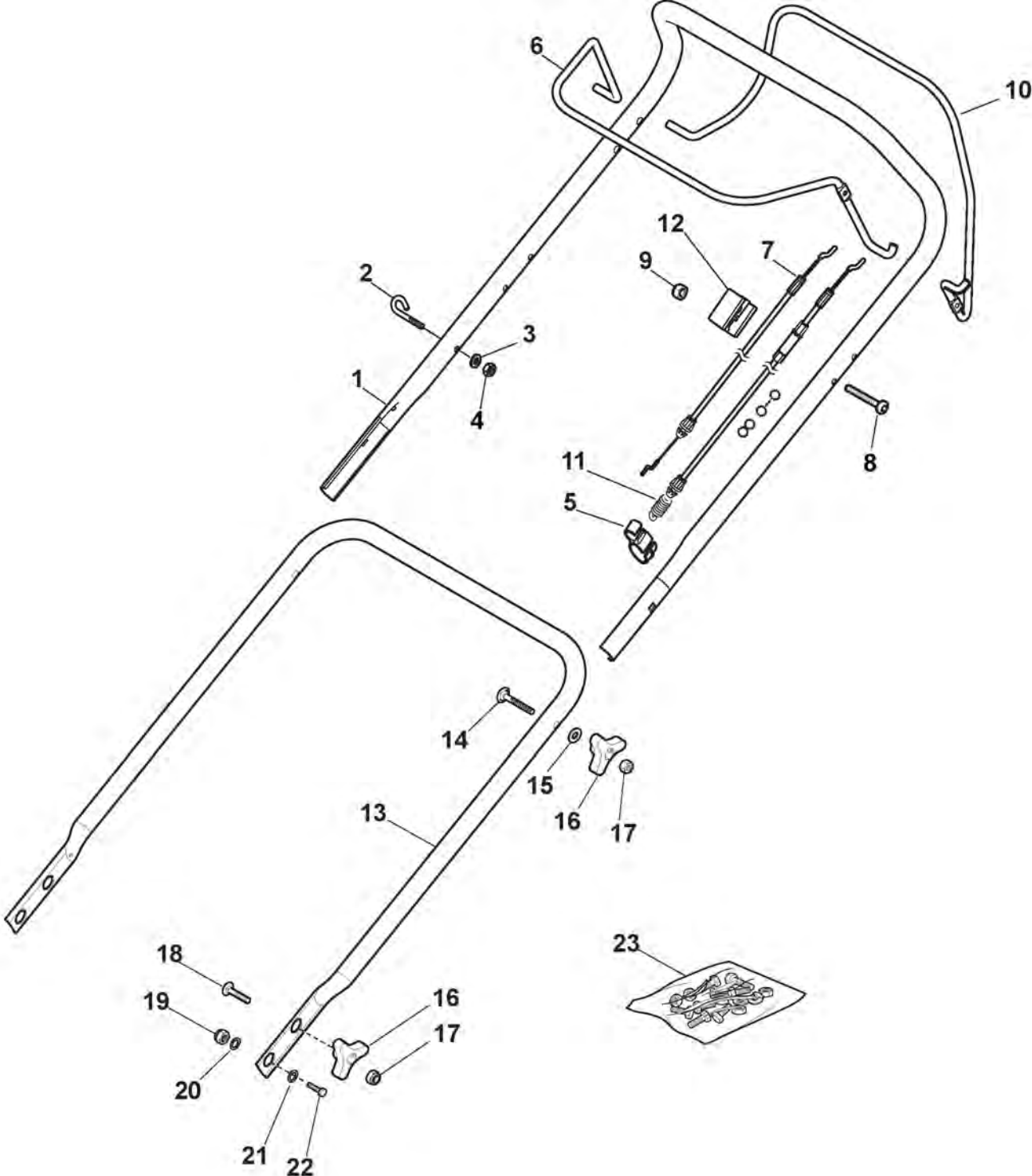

Mancheron, Partie Superieure avec Poignée

Réf. N°	Q.té :	Code article	Description	Articles	De	Jusqu'à
1	1	381006739/1	Mancheron, Partie Superieure	Black without Sponge;To 31-August-2017		
1	1	381006739/2	Mancheron, Partie Superieure	Black without Sponge;From 01-September-2017		
1	1	381006745/1	Mancheron, Partie Superieure avec éponge poignée	Black with Sponge;To 31-August-2017		
1	1	381006745/2	Mancheron, Partie Superieure avec éponge poignée	Black with Sponge;From 01-September-2017 To 31-August-2018		
1	1	381006745/3	Mancheron Noir, Partie Superieure avec éponge poignée	Black with Sponge;From 01-September-2018		
2	1	122430313/0	Ressort De Guide			
3	1	112521330/0	Rondelle			
4	1	112154510/0	Ecrou			
5	1	118390020/0	Fixation Cable			
6	1	381003376/0	Levier Frein Moteur Rouge	Red		
7	1	181030088/0	Cable Frein Moteur			
8	1	112727783/0	Vis			
9	1	112154510/0	Ecrou			
10	1	181003364/0	Levier Traction	Black		
11	1	381030104/0	Câble Embrayage			
12	1	322551640/0	Plaquette			
13	1	381006785/0	Mancheron, Partie Inferieure	Black		
14	2	112819110/0	Vis			
15	2	122671651/0	Rondelle			
16	2	122399900/0	Poignée			
17	2	112293200/0	Ecrou			
18	2	112818900/0	Vis			
19	2	112155000/0	Ecrou			
20	2	112521350/0	Rondelle			
21	2	112369500/0	Disque Elastique			
22	2	112760605/0	Vis			
23	1	381008730/0	Dotation	Black		

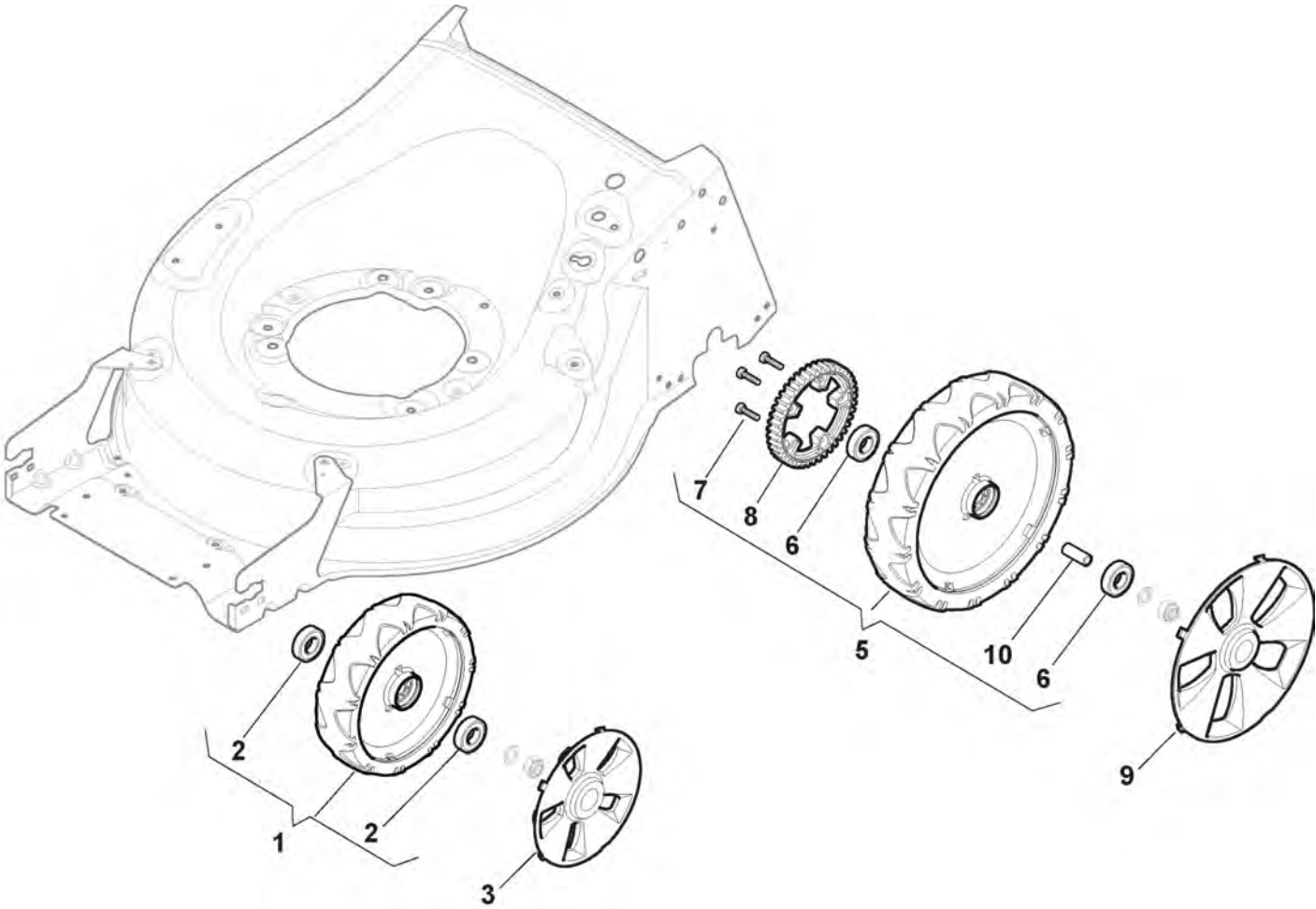

Roues et Couver-Moyeu

Réf. N°	Q.té :	Code article	Description	Articles	De	Jusqu'à
1	2	381007455/1	Roue - Short Hub			
2	4	119216035/0	Roulement			
3	2	322110636/0	Couvre-Moyeu Gris			
5	2	381007467/1	Roue			
6	4	119216035/0	Roulement			
7	6	112728706/0	Vis			
8	2	322120117/0	Couronne			
9	2	322110637/0	Couvre-Moyeu Gris			
10	2	122170848/0	Entretoise			

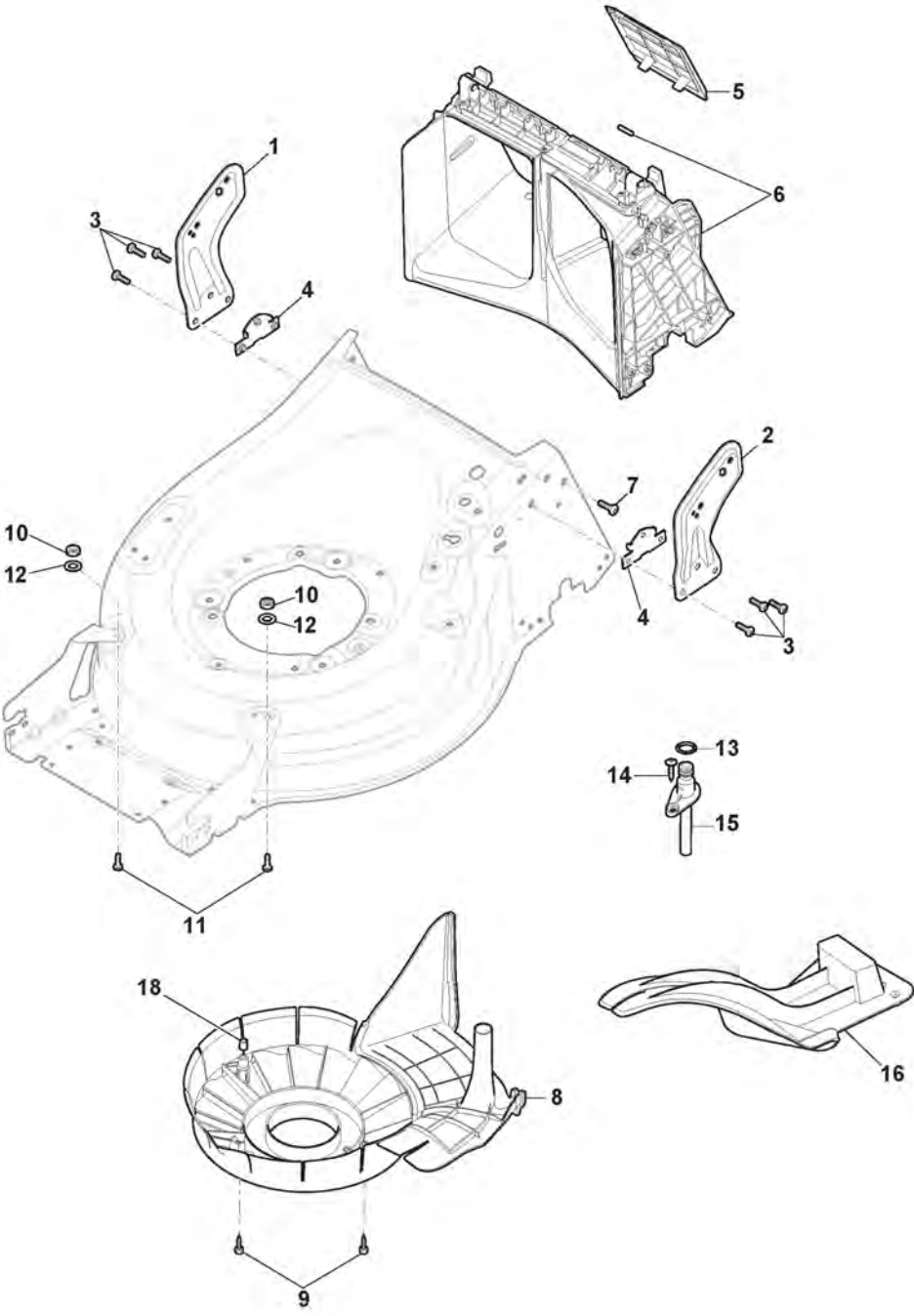

Protection Courroie

Réf. N°	Q.té :	Code article	Description	Articles	De	Jusqu'à
1	1	381005195/0	Etrier Droit	Black;To 31-August-2017		
1	1	381005195/1	Etrier Droit	Black;From 01-September-2017 To 31-August-2018		
1	1	381005195/2	Etrier Droit	Black;From 01-September-2018		
2	1	381005197/0	Etrier Gauche	Black;To 31-August-2017		
2	1	381005197/1	Etrier Gauche	Black;From 01-September-2017 To 31-August-2018		
2	1	381005197/2	Etrier Gauche	Black;From 01-September-2018		
3	6	112727801/0	Vis			
4	2	322545213/0	Plaquette			
5	1	322600310/0	Rear door	Not for TR/E models		
6	1	381102204/0	Rear Baffle Assembly	To S/N 19JA2WBH017664		
6	1	381102204/1	Rear Baffle Assembly	From S/N 19JA2WBH017665		
7	6	112728699/0	Vis			
8	1	322060270/0	Protection Mulching	To S/N SK6112205		
8	1	322060270/1	Protection Mulching	To S/N SK6112095		
8	1	322060270/2	Protection Mulching	From S/N SK8153833 To S/N 19JA2WBH023208		
8	1	322060270/3	Protection Mulching	From S/N 19JA2WBH023209		
9	2	112728530/0	Vis	To 31-August-2015		
9	2	112728531/0	Vis	From 01-September-2015 To 31-August-2016		
9	2	112735645/0	Vis	From 01-September-2016		
10	2	112154510/0	Ecrou			
11	2	112815205/0	Vis			
12	2	112521330/0	Rondelle			
13	1	119035000/0	Joint Or			
14	1	112728697/0	Vis			
15	1	322034002/0	Attaque Lavage			
16	1	322140245/0	Deflecteur			
18	2	122042073/0	Douille	From 01-September-2018		

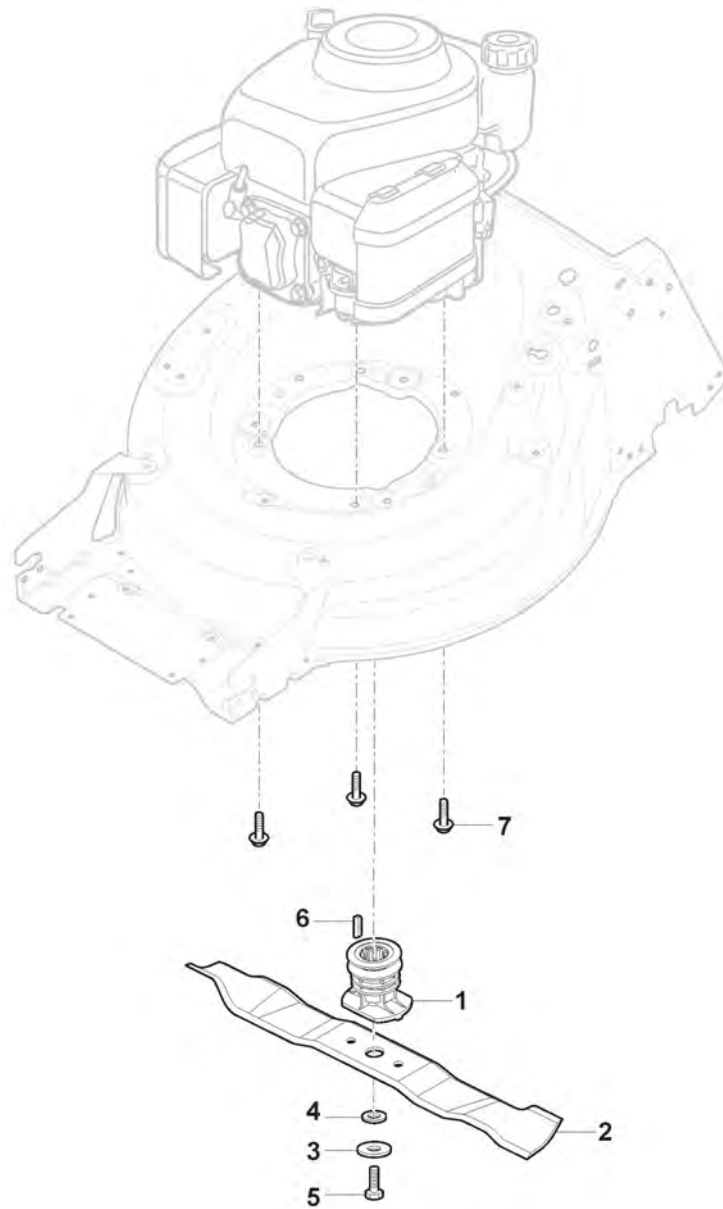

Lame De Coupe

Réf. N°	Q.té :	Code article	Description	Articles	De	Jusqu'à
1	1	122465607/3	Moyeu Avec Poulie, Arbre Moteur Ø 22.2	To 31-december-2018		
1	1	122465607/4	Moyeu Avec Poulie, Arbre Moteur Ø 22.2	From 01-January-2019		
2	1	181004366/2	Lame			
3	1	122160400/0	Disque Elastique			
4	1	112523080/0	Rondelle	To 31-August-2016;Only for 554 Models		
4	1	322680021/0	Rondelle	From 01-September-2016 To 31-August-2019;Only for 554 Models		
4	1	322680021/1	Rondelle	From 01-September-2019;Only for 554 Models		
5	1	112735698/0	Vis			
6	1	112139100/0	Languette			
7	3	112735108/1	Vis			

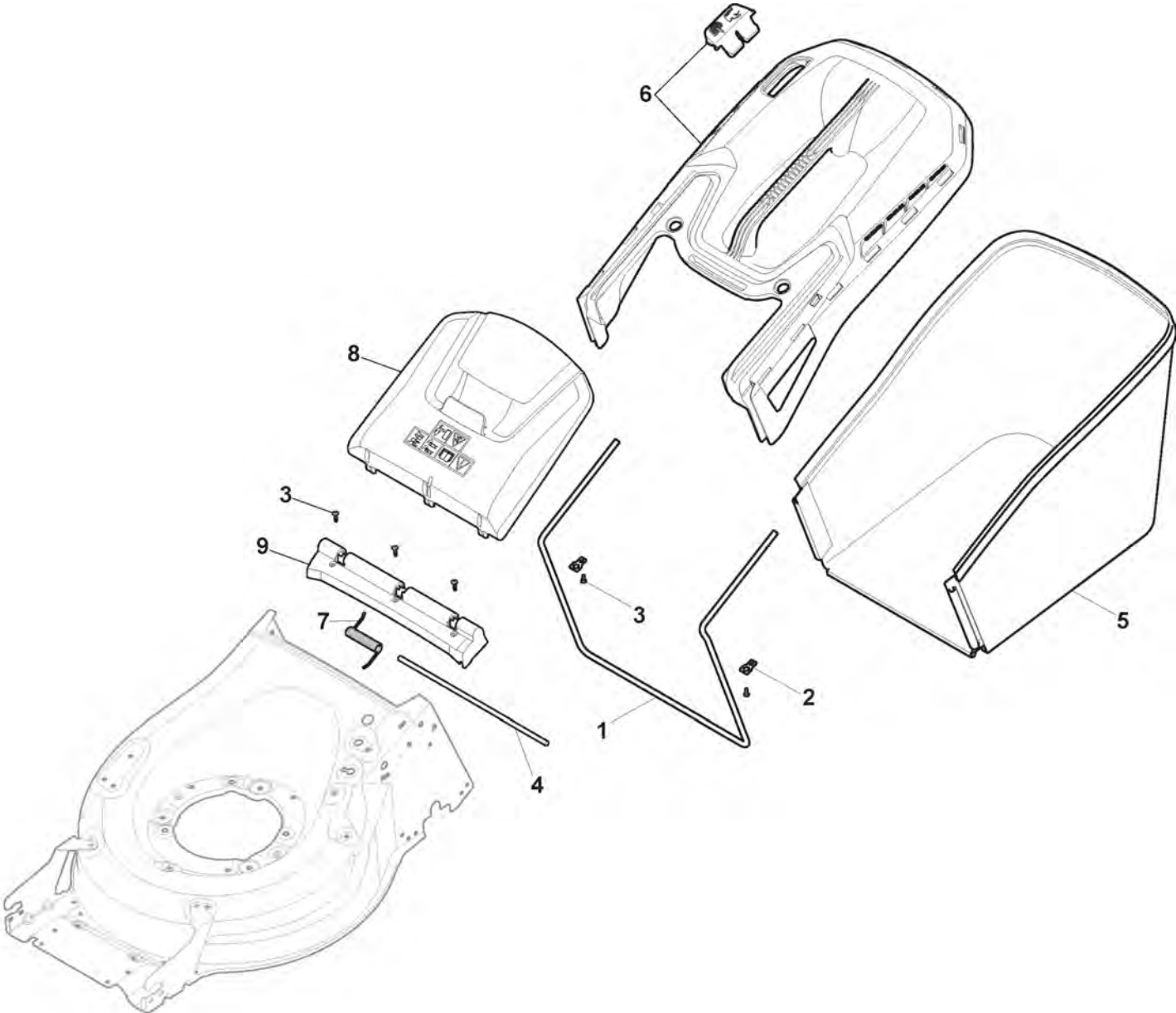

Sac De Ramassage D'Herbe

Réf. N°	Q.té :	Code article	Description	Articles	De	Jusqu'à
1	1	181006411/0	Châssis Bac	To 31-August-2019		
1	1	181006411/1	Châssis Bac	From 01-September-2019		
2	2	322557177/0	Plaquette			
3	5	112728697/0	Vis			
4	1	122517884/0	Pivot			
5	1	181102349/0	Sac, Toile	Black without Logo		
6	1	381486039/0	Sac, Partie Superieure Noir	Black with Grey Indicator		
7	1	122450479/0	Ressort			
8	1	322600308/0	Pare-Pierres, Noir			
9	1	322109569/0	Support Pare-Pierres, Noir			